



Summer Writing Challenge

COMICS
RULE!

YEAH!

YEP!

National
Literacy
Trust

BEANO®

INTERNATIONAL PAPER

REY®

The Conscious Choice

Welcome to your Comics Creators Activity Pack!

Inside this fantastic pack we have included lots of free paper and ideas of what to do with it, as well as activities to help you create a comic of your own!

Never made a comic before? Do not fear – REY Paper, The National Literacy Trust and Beano have teamed up to teach you everything you need to know!

Your pack includes:

- Beano comic strips to enjoy
- A comics scavenger hunt
- How to draw guides – from making the most of stick people to recreating Rey and Beano characters
- Learn skills from top comic creators – including how to use speech bubbles and write a comic script
- Make your own mini-book guide
- Lots of blank frames for you to use for your comic!



COMIC SCAVENGER

HUNT

Have a look at the comics included in your pack – can you spot any of these classic comic features on the pages? If you have your own comics at home, you could search the pages of those too!
How many can you find?

An image drawn from the character's point of view.



A joke!

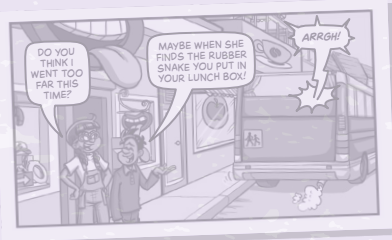

Thought bubbles.



Speech bubbles.
How many different shapes and styles can you find?



A sound effect.



3 different facial expressions.



A drawing that goes outside of the comic's frame.



A close-up on a character's face.



Lines showing the character's movement.



UNSCRAMBLE

Unscramble these letters to find out famous Beano character names



EMMI NINTH NIXE

DES INN

HANGERS

ANN BA MANA



CREATE YOUR OWN STICK PEOPLE COMIC!



You don't have to be an expert artist to make your own comic – you can tell an awesome story using **simple stick people!**

TOP TIPS

Add detail to your character by adding something extra!

This helps the reader to know which character is which. Try to include something that fits with your character.



Hair



Hats

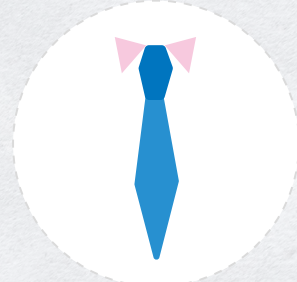

Simple Clothes (e.g. a tie)



Give your stick people emotions.

Adding a few simple lines to a stick person's face can say a lot about how a character is feeling.

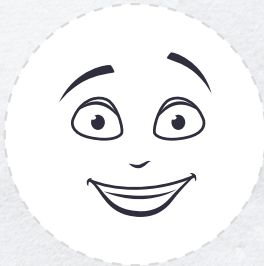

Happy



Shocked

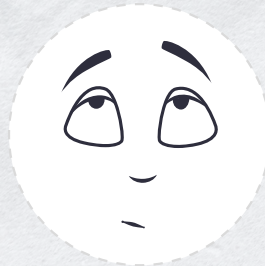

Confused



Angry

HAVE A GO!

Add your own expressions and accessories to these characters...

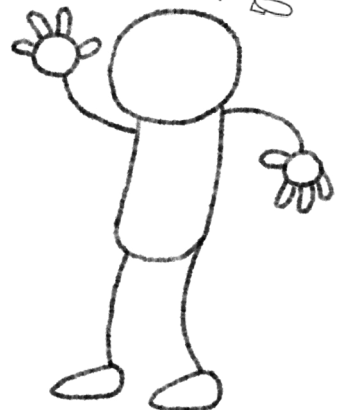
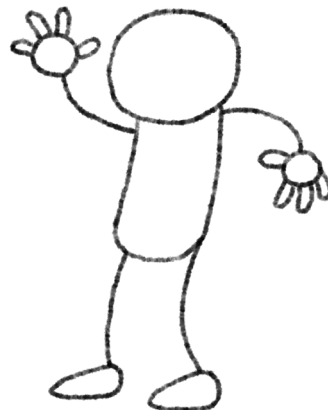

Character name

Character name

Character name

Character name

USING THOUGHT & SPEECH BUBBLES

Thought and speech bubbles are a great way to show what your characters are thinking.

Have a look at this example – **what do you think Melvyn is thinking?**

Fill in the thought bubble!



DID YOU KNOW...

...you can use the line around the bubble to **show more about how your character is feeling or the way that they are talking?**

MATCH UP!

Can you **match up** these **bubbles** to an **emotion or volume?**

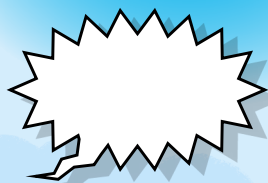

ANGRY
Bold and jagged outline



FRIGHTENED
Irregular wobbly outline

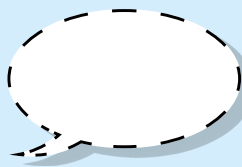

WHISPERING
Dashed outline

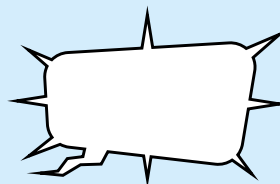

SHOUTING
Zigzag

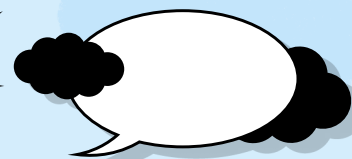

**EVIL CHARACTER/
NEGATIVE THOUGHTS!**
Black cloud background

HAVE A GO!

Use this blank strip to create a comic of your own – Try using at least 2 different types of speech or thought bubble outline.

STUCK FOR IDEAS?

What about retelling part of a **favourite movie or book?**

HOW TO DRAW

Albert
Duck

HELLO THERE!



ready?



STEP-BY-STEP
GUIDE TO DRAWING
ALBERT

If you'd like to have a go at drawing something a little different to a stick person – **why not have a go at drawing your own version of Albert.**
Just follow these simple steps...

1 Let's start with the body

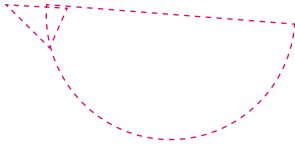

2 Then neck and head

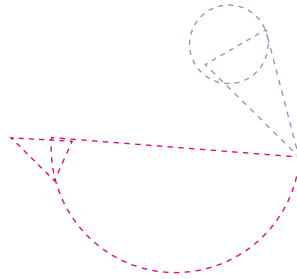

3 Two triangles for the wings

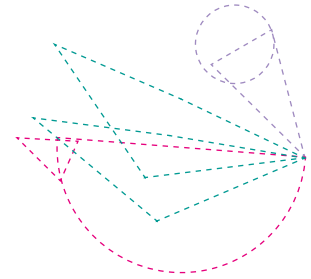

4 Beak, legs and feet

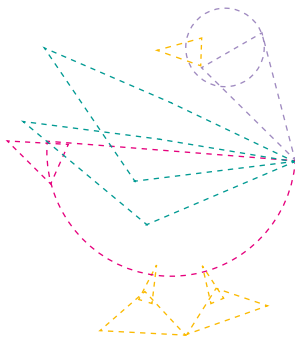

5 Glasses and hat

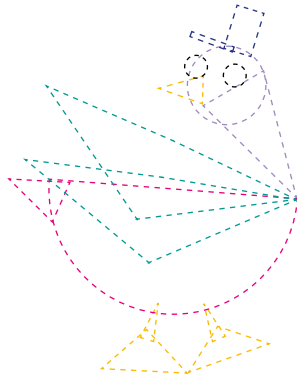

6 Time for colouring



NOW IT'S YOUR TURN.
Use this space to have a go.

TOP TIP

Try drawing lightly first. When you are sure you are happy with what you have drawn, you can **go over in darker pencil or pen!**

HOW TO DRAW MINNIE THE MINX!



STEP-BY-STEP
GUIDE TO DRAWING
**MINNIE
THE MINX**

If you'd like to have a go at drawing something a little different to a stick person – why not have a go at drawing your own version of Minnie the Minx
Just follow these simple steps...

1

Minnie begins with a series of simple shapes – a circle for a head, rectangle for her body and a square for her skirt.



2

Your figure will start to look like Minnie when you add detail like her beret and bows. Don't forget to add Minnie's mischievous grin!



3

Once you're happy with your pencil lines, draw over the top in ink.



4

Rub out the pencil marks and fill in the blacks. Then colour her in!



NOW IT'S YOUR TURN.
Use this space to have a go.

Minnie
Minx



**TOP
TIP**

Try drawing lightly first. When you are sure you are happy with what you have drawn, you can go over in darker pencil or pen!

CREATE YOUR OWN CHARACTER

Have a go at creating your own character...

what sort of person are you creating? Use the prompts around the edge to help build your ideas and then draw your character in the middle.

What is your character's personality? Are they naughty or nice? Friend or foe? Are they calm or do they have a short fuse?

Think about how you could show these things in the way your character looks. Sometimes a character's looks contrast with their personality, other times they match. Which will you choose?

TOP TIP

If you struggle to think of a name you can always use your own!

What is your character's name?

Does the character's name match their personality?

What will they wear? Try to keep it simple as you will have to draw your character lots of times in a comic!

Think about your character's background. **Where do they live? Who do they live with? How old are they? What are their likes and dislikes? Do they have any hobbies? How would they act in different situations?**

Use this space to make some notes:



WHAT

HAPPENS

NEXT?



Comic strips often end on a joke, a **cliffhanger*** or a surprise ending. Take a look at the strips below. We've given you the beginnings. **How will you choose to finish each story?**

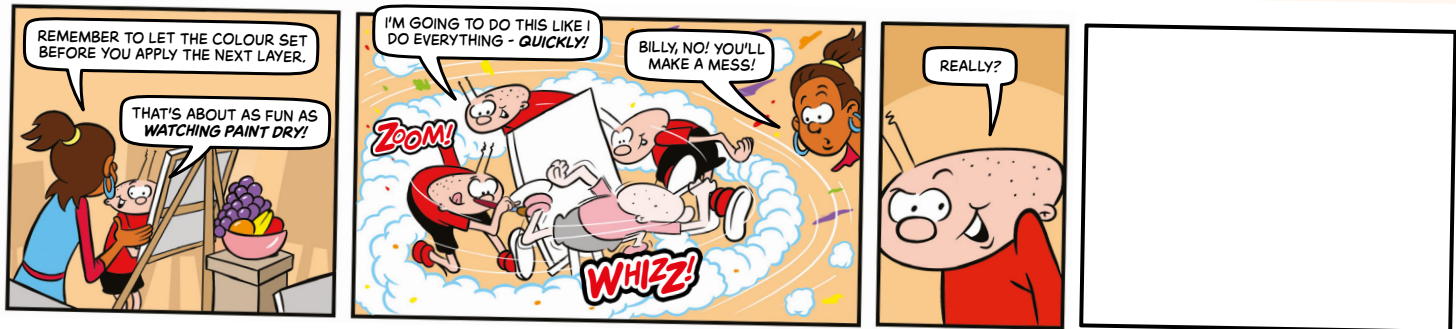
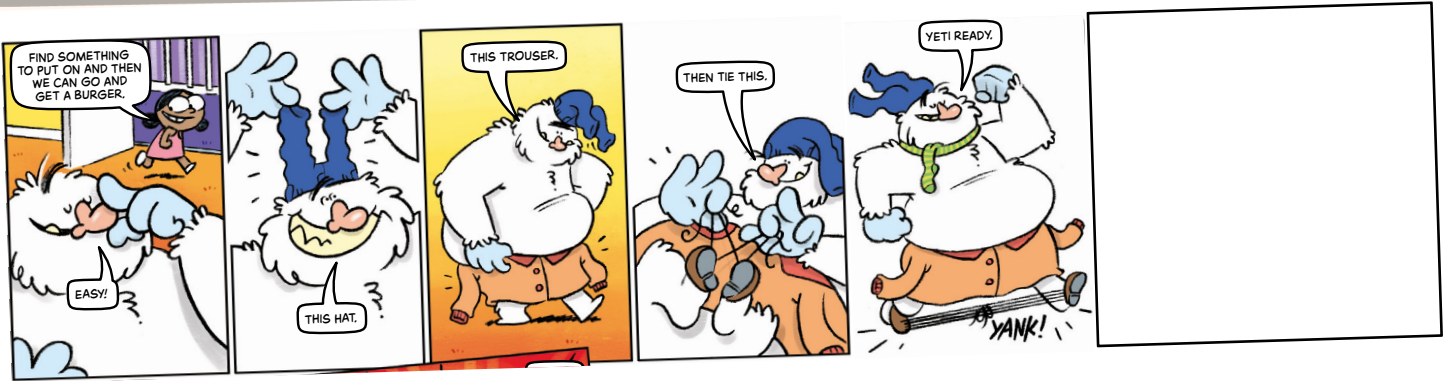
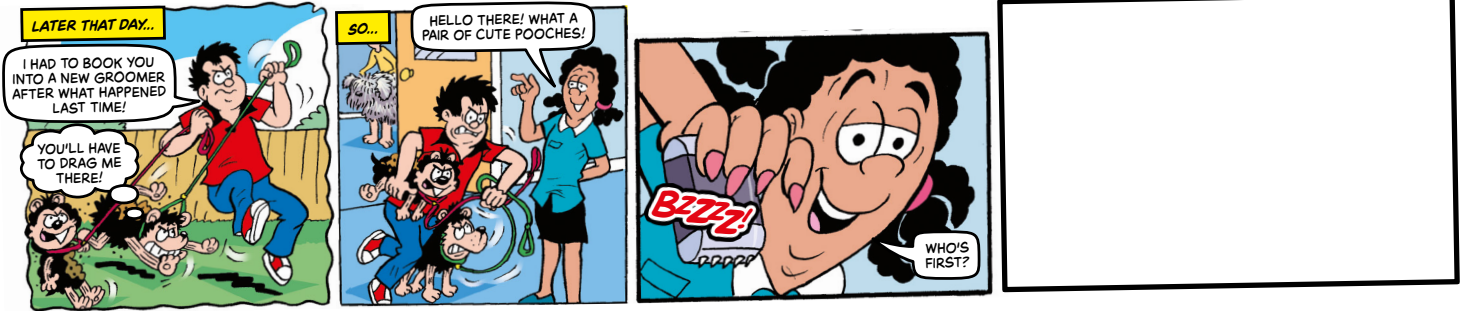

GLOSSARY

*CLIFFHANGER - a dramatic and exciting ending which leaves the audience keen to find out what will happen next!



MAKE YOUR OWN MINI BOOK

Make your very own mini book using this handy step by step guide. You could even use it to write your own Story Quest. All you need is: A4 paper and scissors!

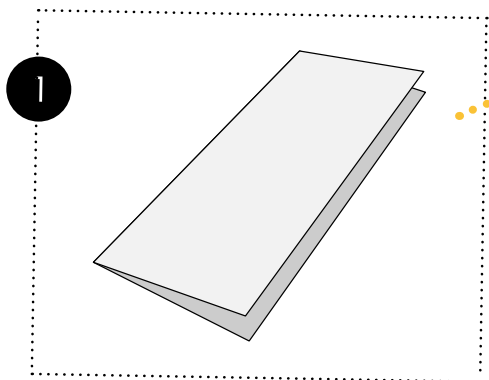

1
Fold a sheet of paper in half lengthwise.

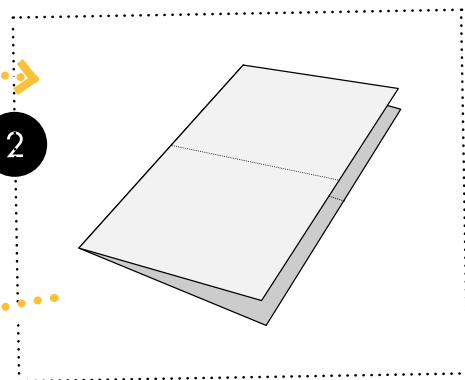

2
Unfold, then fold the paper in half widthwise.

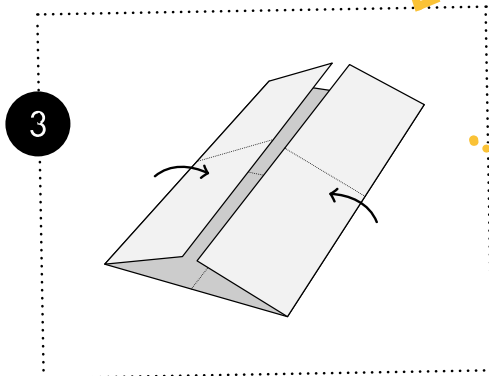

3
Unfold, then fold the edges up to the centre fold.

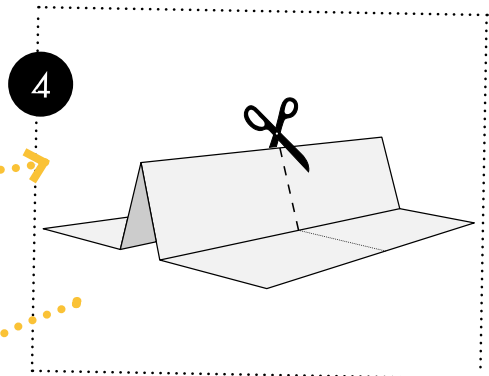

4
Unfold, then fold widthwise and cut a slit only half way down the centre.

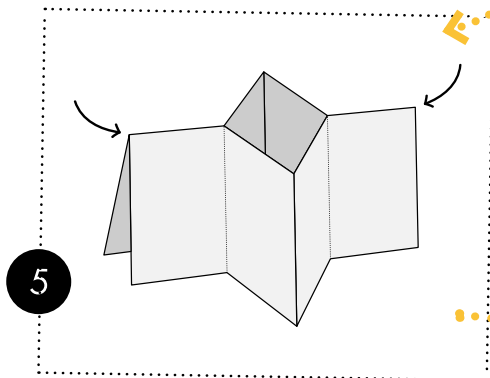

5
Unfold, then fold lengthwise and push the ends in towards the center.

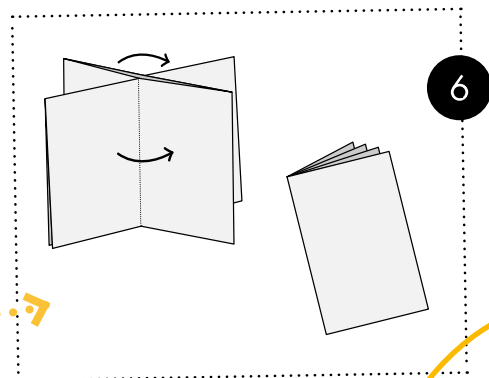

6
Fold all the pages together into a mini booklet.

Ready for you to write your story!



NOW YOU ARE READY TO CREATE YOUR OWN COMIC!

Can you use the skills you have mastered in this pack to create a story of your own? Here are some blank panels to get you started!

Looking for something different? Use the dotted paper included in this pack as a guide to creating panels of any shape or size. You can experiment with panel outlines too - wavy lines, jagged lines, thick or thin lines... It's your comic, so tell your story your way!

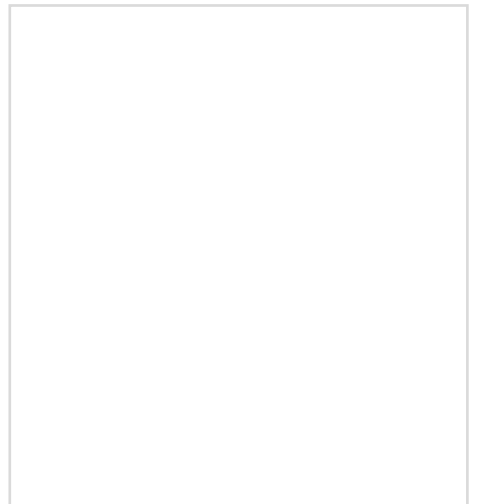
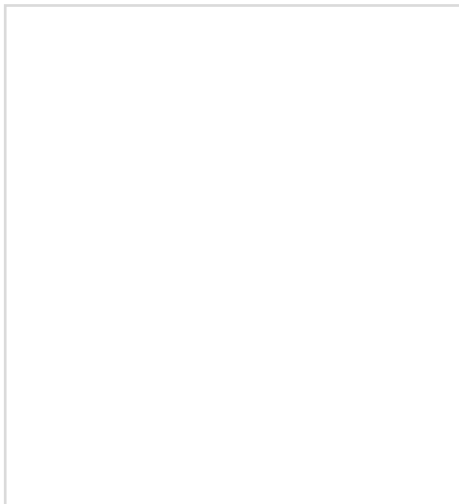
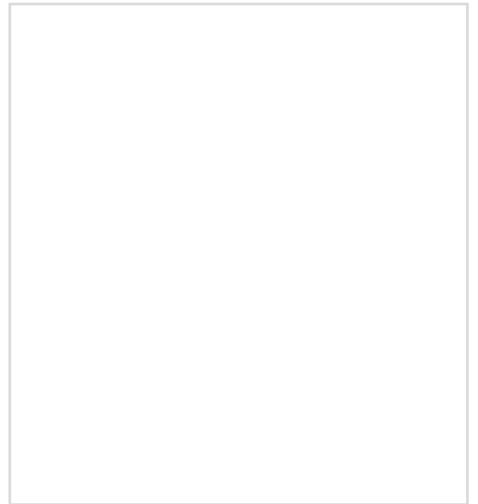
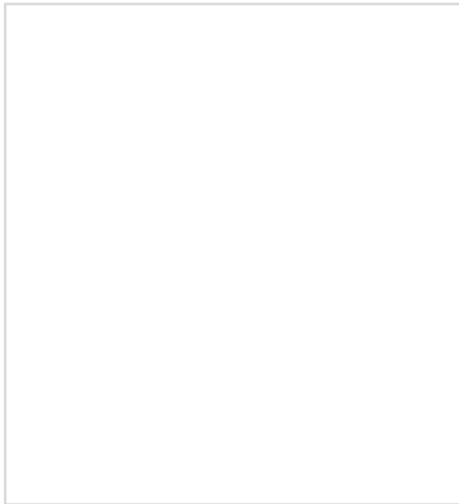
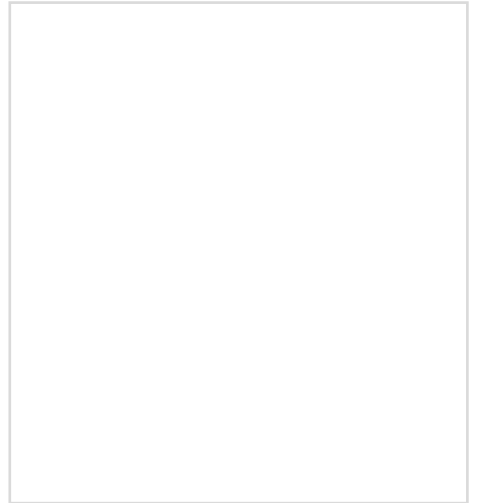
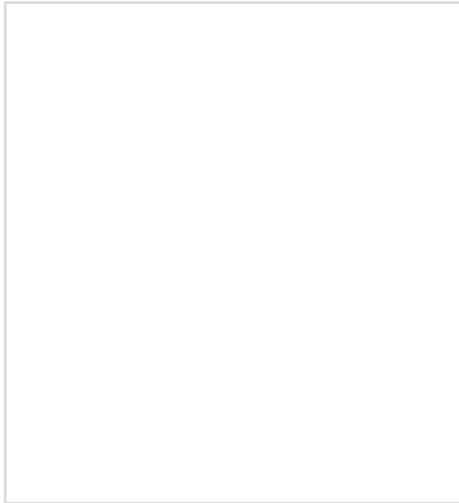



BEANO

INTERNATIONAL PAPER

REY

The Conscious Choice



National Literacy Trust
68 South Lambeth Road, London, SW8 1RL

020 7587 1842 / contact@literacytrust.org.uk

literacytrust.org.uk / rey-paper.com / beano.com